



Cable Protection Systems



CABLEprotect / MULTIduct™

Innovating Underground Network Access

MULTIduct™ is an innovative, lightweight, structural, multiple duct cable protection system that offers a modern alternative to traditional cable ducting systems. Used in the construction of under track or road crossings (UTX/URX), tunnels, bridge crossings and buried linear routes MULTIduct™ offers an easily deployed and accessible cable management system.

Contents

Introduction	02
Product Overview	04
Features & Benefits	06
4 Way MULTIduct™	08
XL 4 Way MULTIduct™	10
6 Way MULTIduct™	12
9 Way MULTIduct™	14
MULTIduct™ Accessories	16
MULTIduct™ Micro	18
Installation & Use	20
Industry Experts	22

MULTIduct™ has been designed to offer seamless integration with Cubis' range of pit access products such as STAKKAbOX™ ULTIMA Connect, enabling enhanced cable management and access. MULTIduct™ can be integrated into the STAKKAbOX™ access pit on-site, or alternatively spigots can be pre-assembled and delivered as a single unit. If the exact duct entry positions are unknown at the time of order a flexible sliding backfill barrier can be fitted. This barrier allows for up to 150mm vertical alteration enabling the MULTIduct™ entry position to be customised on-site.



Product Overview

MULTIduct™ is a multiple duct cable protection system, used for constructing underground ducting systems for under track or road crossings (UTX/URX), tunnels, bridge crossings and buried linear routes.

MULTIduct™ units are quickly assembled by connecting metre long sections with a unique push-fit system. The MULTIduct™ system offers a wide range of accessories to deal with tight turns, elevations, adjustable height on-site, natural curvature and other obstacles.

Manufactured from high density polyethylene, MULTIduct™ offers a lightweight, high strength-to-weight unit. With parts weighing below 20kg MULTIduct™ offers significant health and safety advantages permitting a single person lift and install. Being lightweight and easy to install results in considerable project time and cost savings. Requiring shallower burial depths and with greater crush-resistance than conventional methods, MULTIduct™ easily resolves engineering challenges for cable installation.

Sectors

Suitable for use in any infrastructure project MULTIduct™ offers unique features, accessories and applications within the Rail, Light Rail, Power, Telecoms and Highways sectors. With PADs approval for Network Rail, MULTIduct™ offers the ideal solution for modern rail, station and tunnelling projects.



Rail



Light Rail

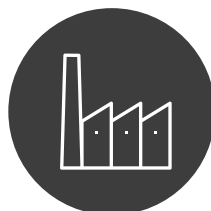

Power



Telecoms



Highways

Applications

MULTIduct™ holds numerous global approvals and has been installed in various applications and environments across the world.



Under Track Crossings



Under Road Crossings

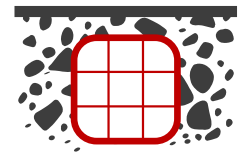

Buried Cable Routes

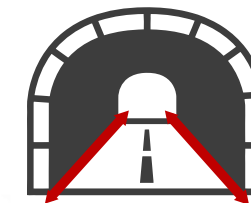

Tunnels

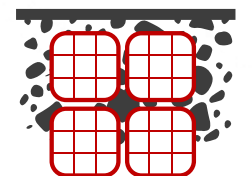

Multi-bank

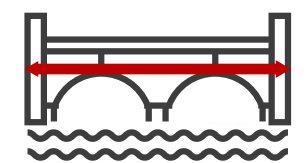

Bridge Crossing

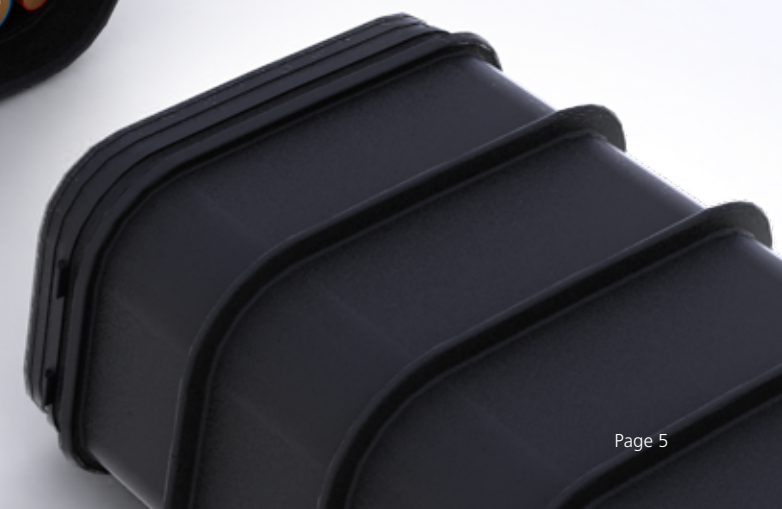

Features & Benefits

High Crush Strength

Requiring shallower burial depths and with greater crush-resistance than conventional methods, MULTIduct™ does not require any concrete or specialist surround due to its high strength and robust nature. Excavated material can be reused during re-installation reducing time, cost and heavy plant.

Lightweight

Weighing under 20kg MULTIduct™ offers significant health and safety advantages. MULTIduct™ is suitable for a single person lift and install, enabling compliance with manual handling regulations. Being lightweight and easy to deploy results in considerable project time and cost savings.

Durable

Less susceptible to drop related damages MULTIduct™ offers a durable lightweight unit that can be easily transported and moved on-site. MULTIduct™ units also incorporate large radius corners to stop rodents biting through the duct unit to gain access to cabling.

Quick Assembly with Secure One Click Connection System

MULTIduct™ offers a unique 'push fit system' that is fast and easy to install. During cable pulling the unique push-fit connection eliminates any disengagement of the units once installed.

Buried Cable Routes

In conjunction with Cubis' STAKKAbOX™ access pit systems MULTIduct™ can offer a more secure ducting system than surface routes. This can help the problem of theft or vandalism to cables.

Lays Straighter and Flatter with added Flexibility

MULTIduct™ allows for 2° of flexibility within its connection. This results in the creation of a natural bend that can follow the curvature of a track, road or tunnel installation. The straight lay flat feature removes the need for spaces and eliminates any twisting issues during the installation unlike traditional ducting systems.

Multiple ducts combined into one part

MULTIduct™ combines multiple cable ducts that would traditionally be separated. This results in the need for a reduced excavation meaning narrower, shallower trenches, no graded backfill between ducts and reduced time, during installation.

Square Duct Space

Unique smooth internal walls for easier cable pulling and no sharp edges for cable damage. Less surface contact with cables makes it easier to pull / blow during cable installation. The shape of the MULTIduct™ units increase capacity over traditional cable ducts.

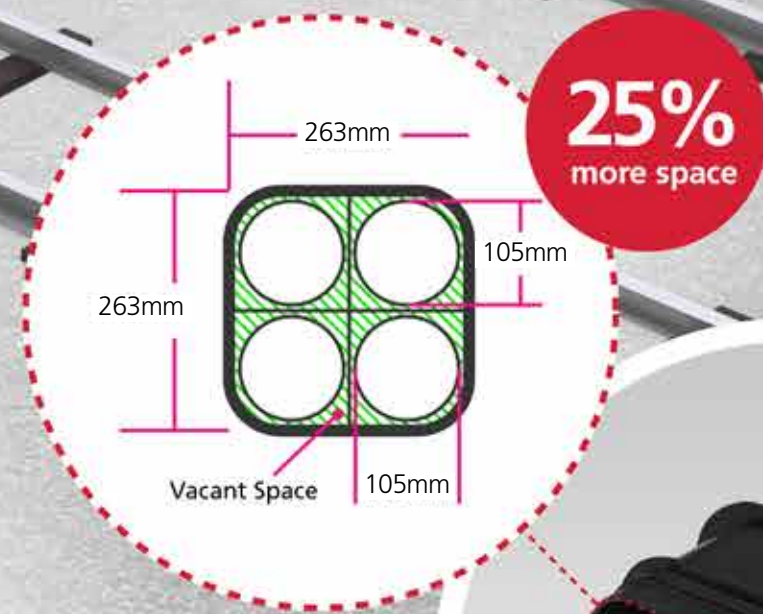

4 Way MULTIduct™

Each duct space is equivalent to 110mm single duct



4 Way Unit

L263mm x W263mm x D1116mm
Weight: 6.8kg



4 Way Socket End Cap

L255mm x W255mm x D73mm
Weight: 1kg



4 Way Spigot End Cap

L252mm x W252mm x D78mm
Weight: 1kg



4 Way Single Duct Adapter

L250mm x W250mm x D200mm
Weight: 1kg



4 Way Double Socket

L255mm x W255mm x D125mm
Weight: 1kg



4 Way Double Spigot

L252mm x W252mm x D135mm
Weight: 1kg

XL 4 Way MULTIduct™

Each duct space is equivalent to 160mm single duct



4 Way Unit (160mm)

L384mm x W384mm x D1116mm
Weight: 16.3kg



4 Way (160mm) Socket End Cap

L370mm x W370mm x D73mm
Weight: 1.4kg



4 Way (160mm) Spigot End Cap

L369mm x W369mm x D78mm
Weight: 1.4kg



4 Way Single Duct Adapter

L368mm x W368mm x D213mm
Weight: 3.3kg



4 Way (160mm) Double Socket

L370mm x W370mm x D125mm
Weight: 1.3kg



4 Way (160mm) Double Spigot

L369mm x W369mm x D135mm
Weight: 1.3kg

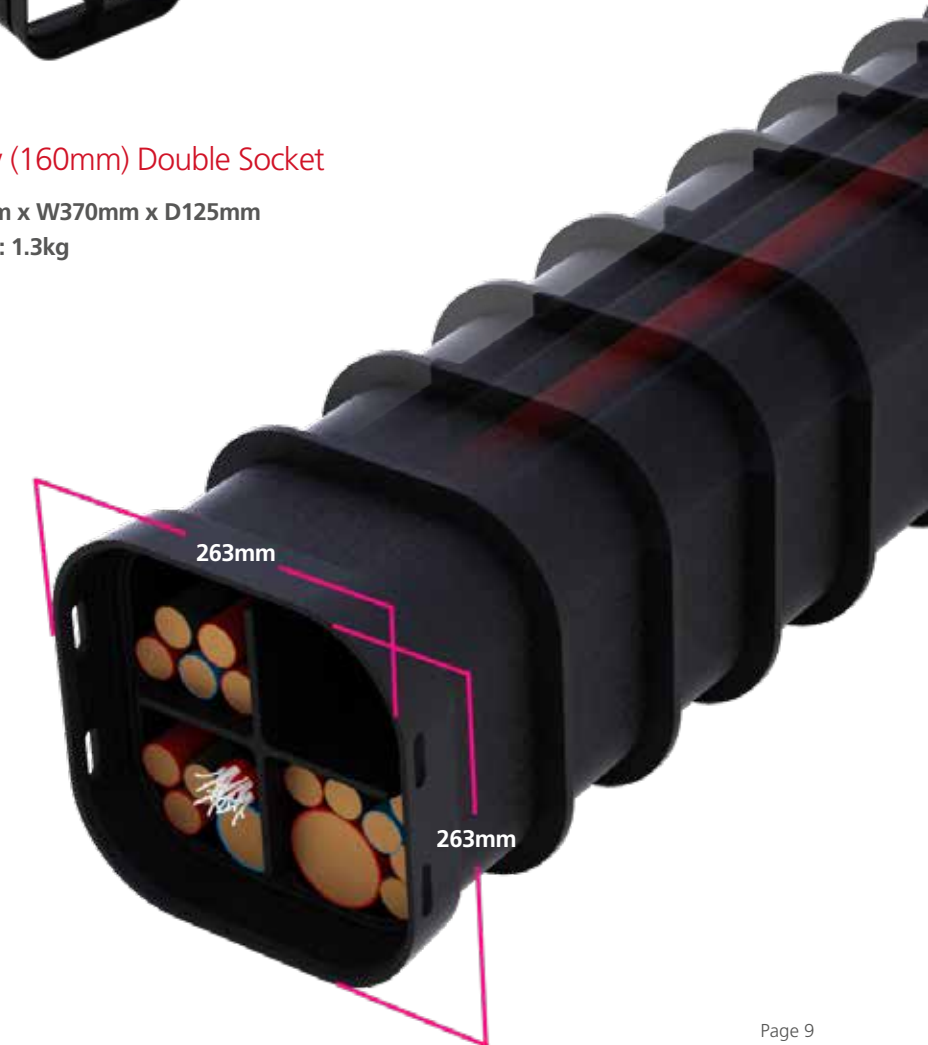

6 Way MULTIduct™

Each duct space is equivalent to 110mm single duct.



6 Way Unit

L372mm x W265mm x D1116mm
Weight: 10.3kg



6 Way Single Duct Adapter

L365mm x W250mm x D200mm
Weight: 2.4kg



6 Way Socket End Cap

L363mm x W256mm x D73mm
Weight: 1kg



6 Way Spigot End Cap

L360mm x W253mm x D78mm
Weight: 1.3kg



6 Way Double Socket

L363mm x W256mm x D125mm
Weight: 1kg



6 Way Double Spigot

L360mm x W253mm x D135mm
Weight: 1kg

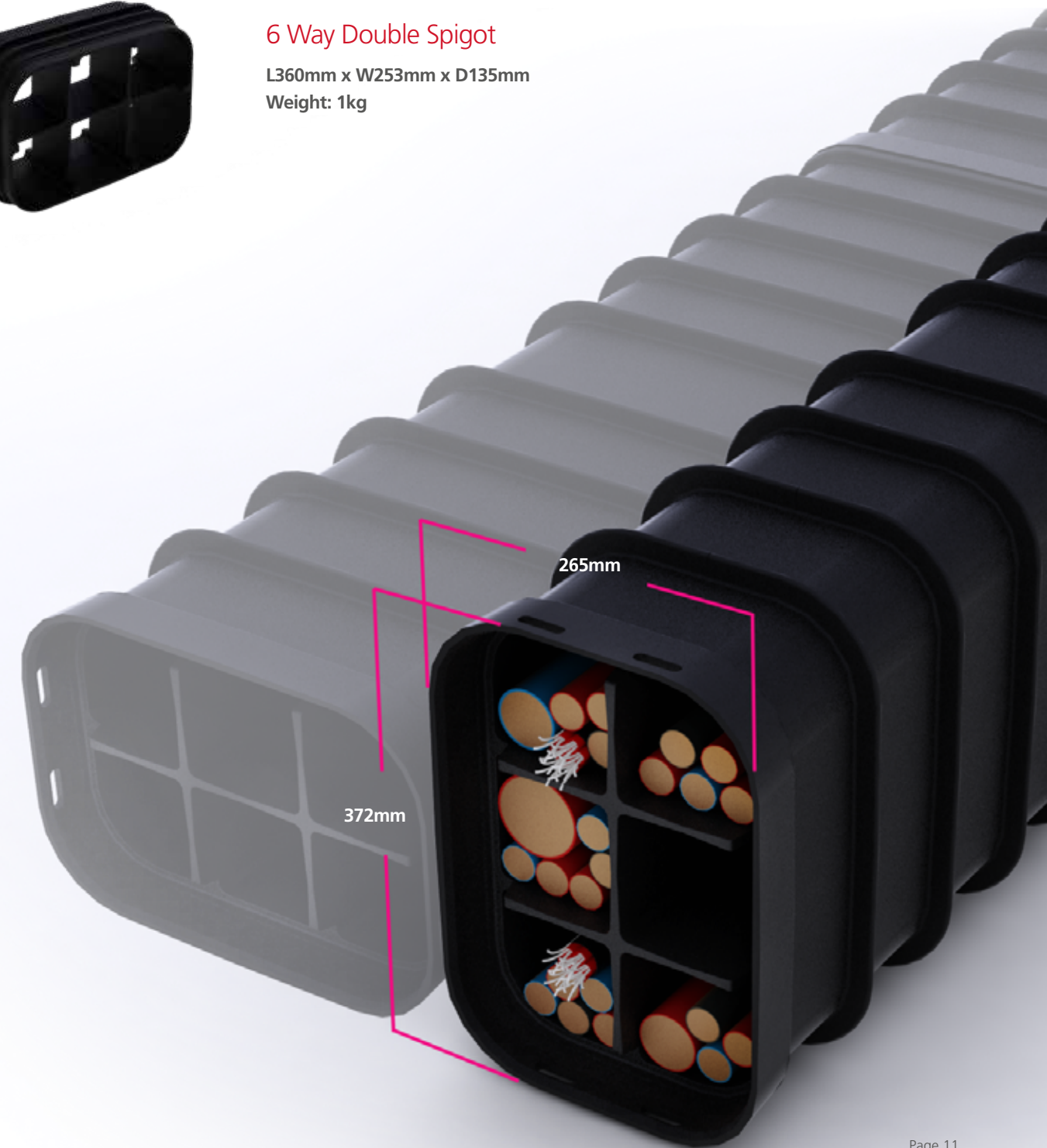

9 Way MULTIduct™

Each duct space is equivalent to 110mm single duct.



9 Way Unit

L384mm x W384mm x D1116mm
Weight: 16.2kg



9 Way Single Duct Adapter

L375mm x W375mm x D200mm
Weight: 3.3kg



9 Way Socket End Cap

L370mm x W370mm x D73mm
Weight: 2kg



9 Way Spigot End Cap

L369mm x W369mm x D78mm
Weight: 1.7kg



9 Way Double Socket

L370mm x W370mm x D125mm
Weight: 1.7kg



9 Way Double Spigot

L369mm x W369mm x D135mm
Weight: 1.6kg

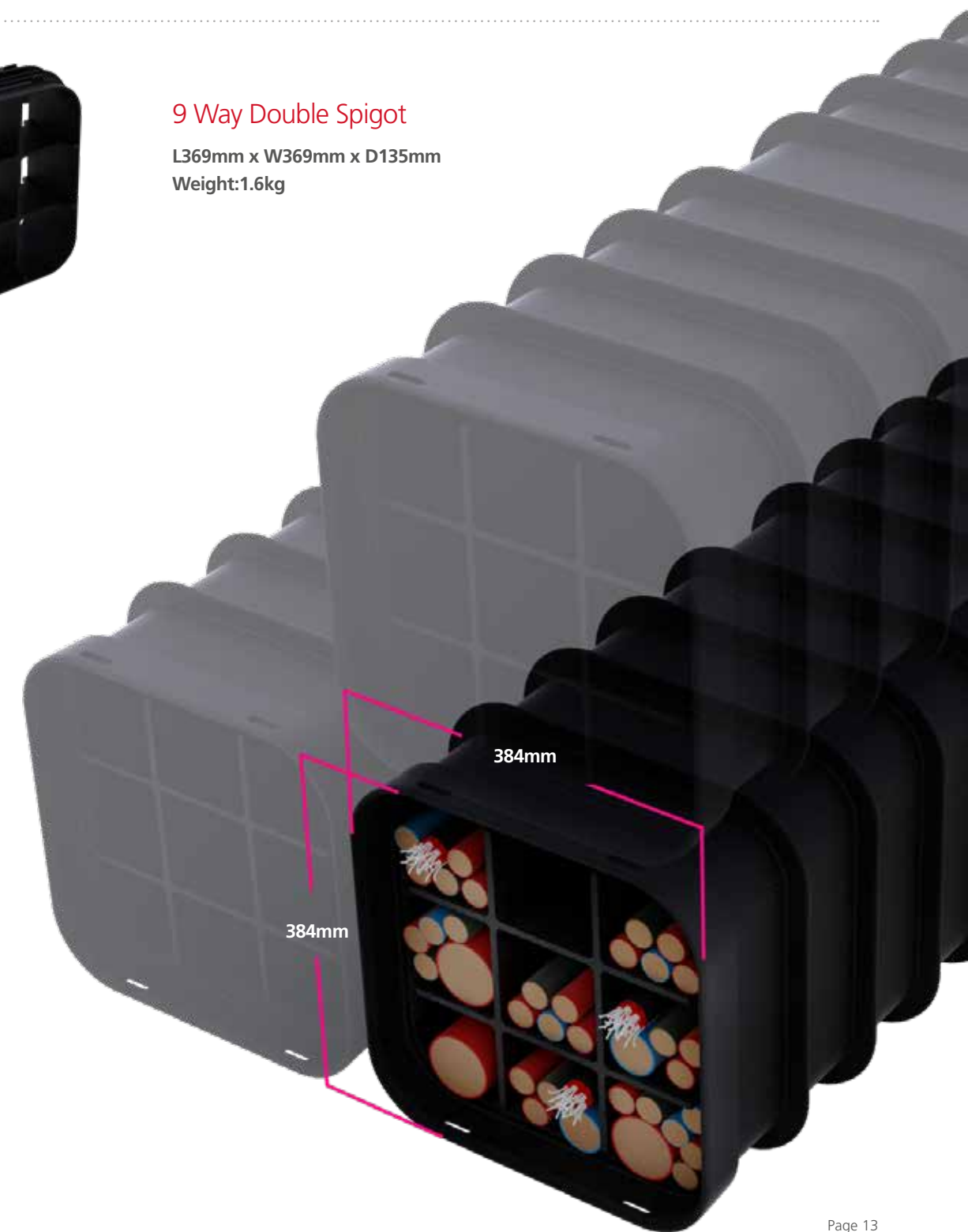

MULTIduct™ Accessories

Split Repair Kit:

Should it become necessary to repair a damaged or faulty cable within a linear run, a split repair kit can be used once the excavated area and MULTIduct™ unit has been removed. The split repair kit is used to replace the parts of the MULTIduct™ that have been removed.



2 Degree of Flexibility:

MULTIduct™ allows for 2° of flexibility within its connection, this results in the creation of a natural bend that can follow the curvature of a track, road or tunnel installation.



Multiple Banks:

Duct banks are quickly assembled by connecting meter long sections then stacking these one on top of each other. These individual units or multiples can be joined together in the trench to provide a multiple bank system. These multiple bank systems can be stacked as high as required.

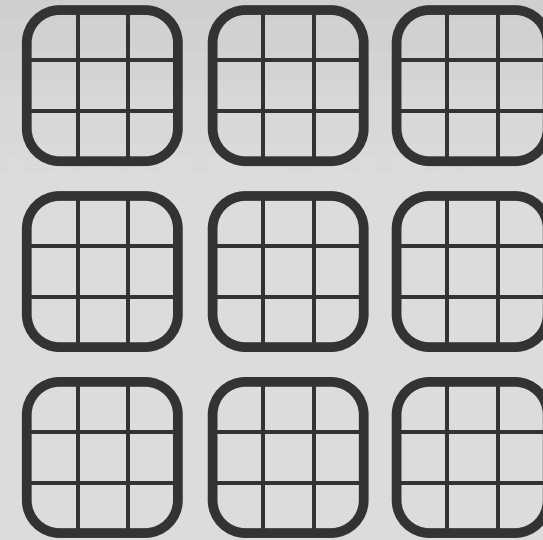

Degree Mitres:

The MULTIduct™ mitres have been designed to assist in any curvature needed within specified linear routes. The unique push fit assembly of the mitre units can be adjusted to turn either right or left to accommodate the required meter bend radius.



4 Way Rubber Gasket

Diameter Ø: 222mm x D20mm
Weight: 0.06kg

4 Way XL Rubber Gasket

Diameter Ø: 335mm x D20mm
Weight: 0.09kg

6 Way Rubber Gasket

Diameter Ø: 280mm x D20mm
Weight: 0.07kg

9 Way Rubber Gasket

Diameter Ø: 335mm x D20mm
Weight: 0.09kg



Quick Assembly with Secure One Click Connection System:

MULTIduct™ offers a unique push fit system that is fast and easy to install. The push fit connection eliminates any pull apart of the MULTIduct™ units once installed during cable pulling.

3 Way Unit

L376mm x W125mm x D1120mm
Weight: 6.8kg



Spring Clips

L70mm x W25mm x D13mm
Weight: 0.01kg



4 Way 22.5° Y-Lateral (Type 2 for 160mm Port)

L147mm x W200mm x D515mm
Weight: 1.04kg

*Other variances can be fabricated and supplied.

4 Way 45° Y-Lateral (Type 2 for 160mm Port)

L126mm x W220mm x D340mm
Weight: 0.54kg

*Other variances can be fabricated and supplied.



MULTIduct™ Accessories

MULTIduct™ has been designed to offer seamless integration with the Cubis range of cable protection and access pit products such as ULTIMA Connect and PROtrough enabling enhanced cable management and access.

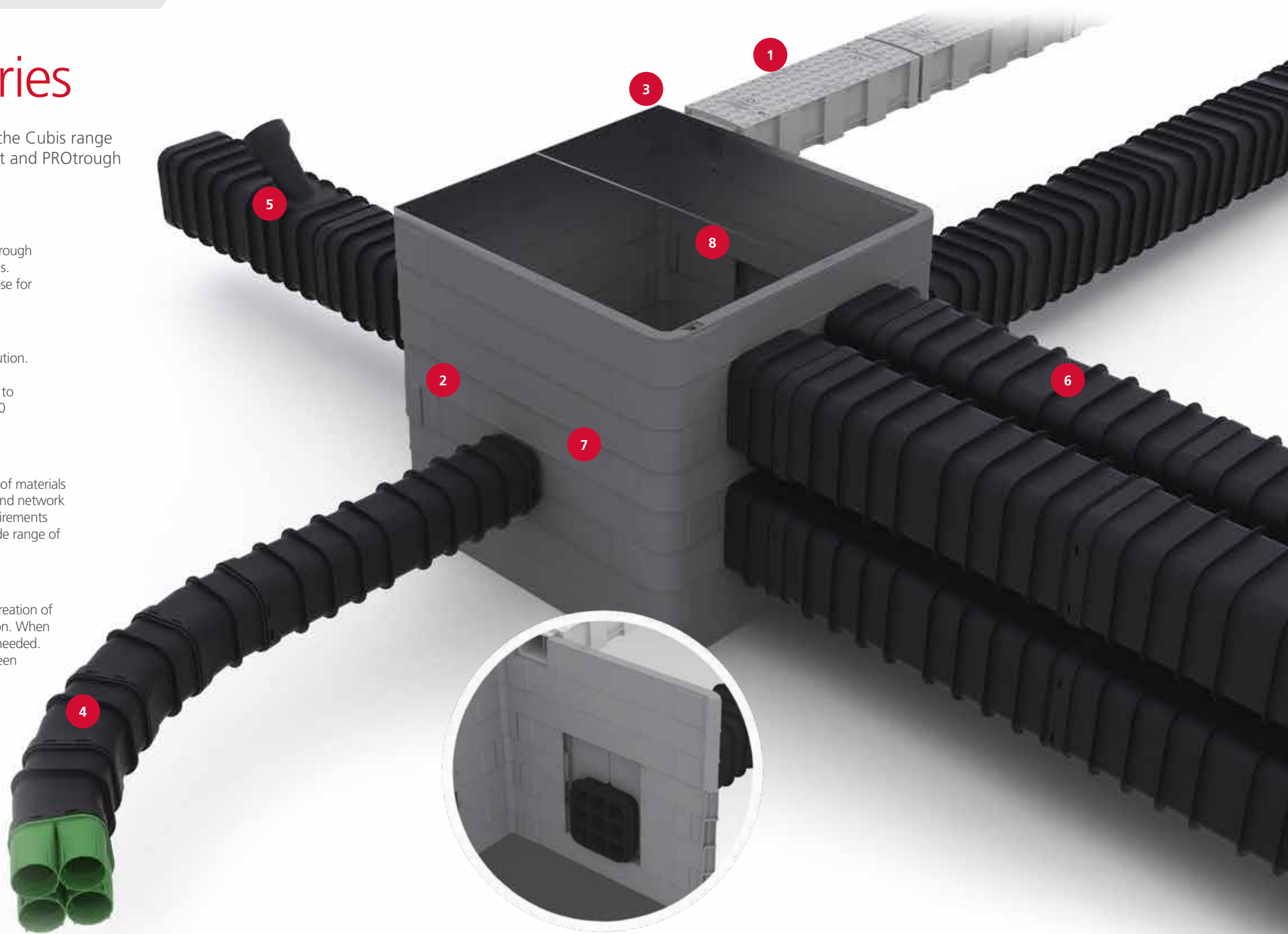

1 PROtrough

PROtrough is an innovative, lightweight, fire retardant and heat resistant cable trough system that offers a modern alternative to traditional concrete troughing systems. Designed to comply with all European fire retardant specifications, including those for tunnels and stations.

2 STAKKAbOX™ Access Pits

Cubis' access pit systems offer an innovative, lightweight structural scalable solution. Available in a variety of sizes that are easily adaptable and fast to install on-site. STAKKAbOX™ access pits, offer a 150mm deep stackable unit that can be built to the desired height required achieving unsupported vertical load test results of 60 tonnes.

3 AX-S™ Access Covers

The Cubis range of access covers are designed and manufactured from a range of materials to complement our pit ranges to provide customers with a complete underground network access system. The AX-S™ range can be tailored to meet specified loading requirements from pedestrian (B125) up to carriageway (D400) duty and are available in a wide range of clear opening dimensions and depths.

4 Duct Adaptor & Degree Angles

MULTIduct™ allows for 2° of flexibility within its connection, this results in the creation of a natural bend that can follow the curvature of a track, road or tunnel installation. When greater bends are required Cubis has designed mitres to assist in any curvature needed. Single way duct adaptors can also be used to offer a seamless integration between traditional ducting and the MULTIduct™ unit.

5 Breakout

Y-Laterals are used when the requirement for one or more cable(s) is required to break out of the MULTIduct™ unit. The Y-Laterals come in 22.5° and 45° as standard with other variances available when required.

6 Multi-bank

MULTIduct™ and MULTIduct™ Micro can be installed in formations or stacked to provide multiple duct banks. Multi-banks can be stacked as high as required and can provide a smooth course of linear buried ducting.

7 Pit Accessories

Using Cubis access pit systems accessories can help save even more time. Our pit options & accessories range of steps, cable management, spigots, duct entries and pit bases allows installers to simply place, connect up tubes or ducts, backfill and walkaway.

8 Adjustable UTX

The adjustable UTX system is an innovative track or road side (UTX/URX) inspection access pit system that offers an adaptable MULTIduct™-invert-level. The system incorporates a sliding backfill barrier that's easily adjusted up to 150mm on site to achieve the correct ducting level required.

MULTIduct™ Micro

MULTIduct™ Micro units are quickly assembled by connecting 500mm long sections with a unique push-fit system, designed to offer an enhanced cable management solution when construction is restricted due to space.

The MULTIduct™ Micro has been developed to be used in the construction of under road crossing (URX), bridge crossings and buried linear routes.



Under Road Crossings



Buried Linear Routes

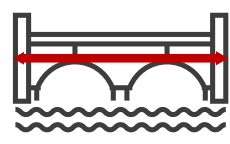

Bridge Crossing

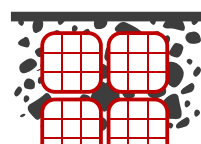

Multi-bank

Size Range

MULTIduct™ Micro (4 way)

L154mm x W154mm x D500mm
Weight: 3kg



MULTIduct™ Micro (6 way)

L210mm x W154mm x D500mm
Weight: 3kg



Duct space on
4 / 6 Way is
50mm x 50mm

Manufactured from High Density Polyethylene, MULTIduct™ Micro offers a lightweight high strength-to-weight structural unit offering a modern alternative to traditional cable ducting systems. With parts weighting below 3kg MULTIduct™ Micro is easy and fast to install resulting in considerable project time and cost savings.



Duct face and inner ducts can be sealed to enhance cable blowing capabilities

Units are connected with push-fit design - fast and easy to complete

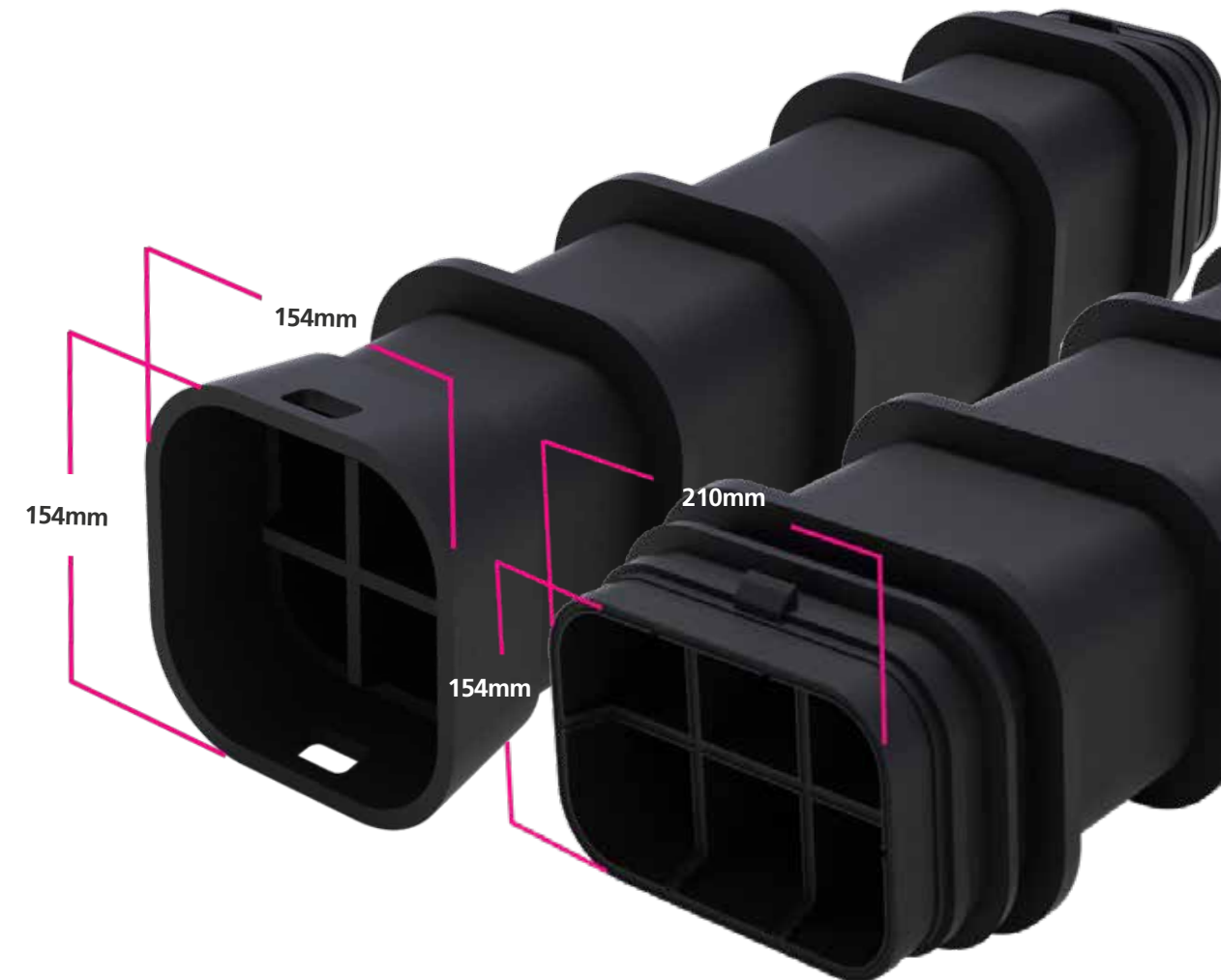

Installation & Use

MULTIduct™ has been designed to offer seamless integration with Cubis' range of pit access and cable protection systems. The combination of being lightweight and easy to deploy in a reduced excavation, makes MULTIduct™ the ideal solution for cable ducting construction.

The MULTIduct™ system offers a fast push fit connection that will speed and simplify the overall installation process for any application. Reduced trench excavation provides a safer and quicker working environment reducing costs and time.

6 simple steps can be followed to ensure the correct, ease, safe and speed of installation.



* for detailed installation instructions see Cubis Systems MULTIduct™ Installation Manual

Lay MULTIduct part and fit next part in

Lay Base

Dig Trench

Backfill

Reinstate Surface

Compact

Manufacturing process

MULTIduct™ is manufactured from High Density Polyethylene. All MULTIduct™ components are produced using the 'Structural Foam' moulding process which is similar to injection moulding. However the difference is that inert gas (nitrogen) is used to create a foam inner core within the part's wall while retaining an integral exterior skin. The lightweight parts and click-fit joints allow for a quick and easy installation.

The following shows recommended burial depths for each MULTIduct product in various applications:

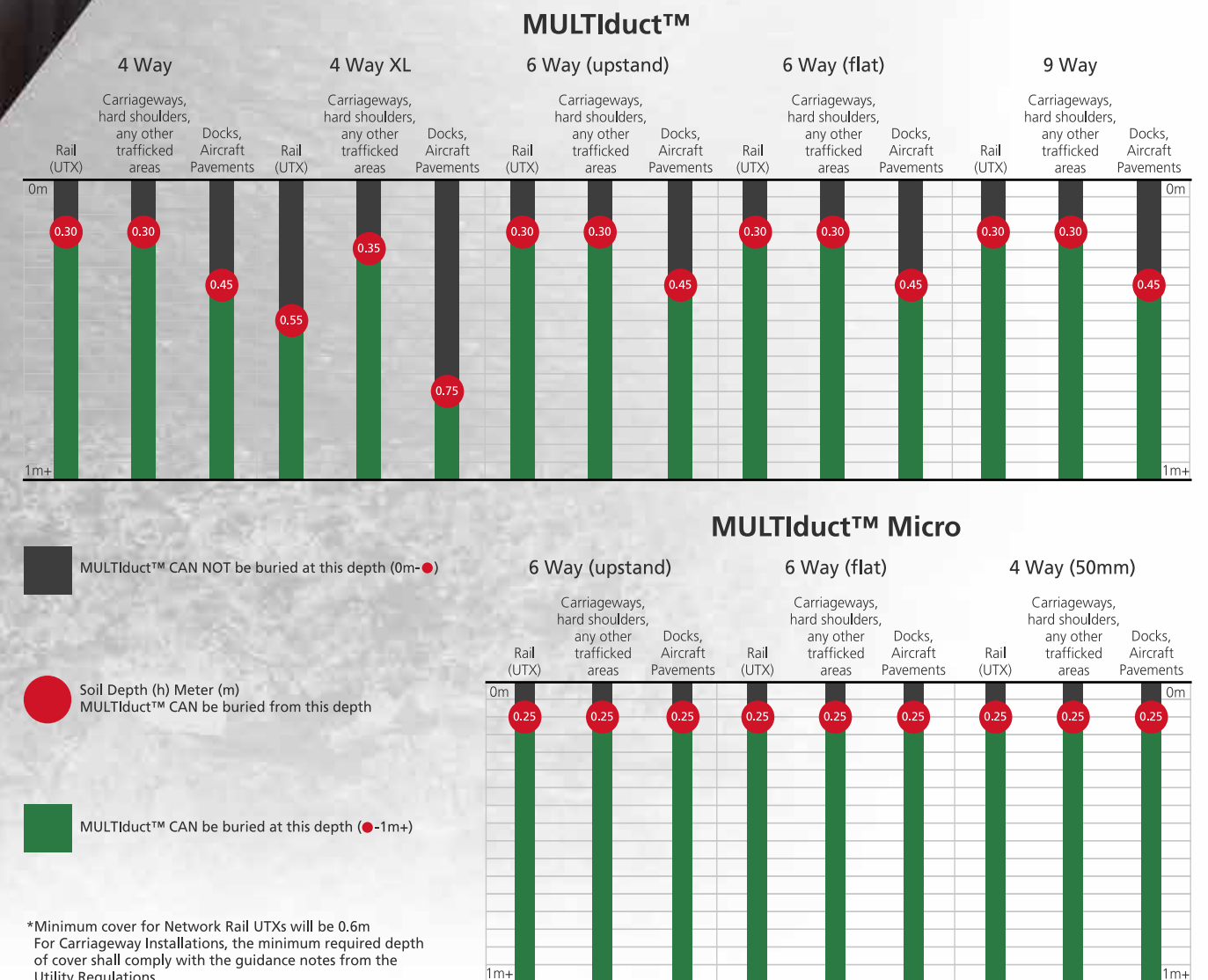

Industry Experts

Cubis' products are innovative, lightweight and significantly reduce costs of in-situ construction through time savings. Cubis integrated systems approach offers our customers a complete range of access pits, access cover and cable protection systems. These products have been installed worldwide into key construction sectors Telecoms, Highways, Rail/Light Rail, Water and Power & Energy. Cubis' products are used within many different applications within each sector from buried cable routes to access pit solutions.

Buried Cable Routes:

Buried cable routes offer a secured and environmentally friendly way to bury trackside cabling. The Network Rail approved buried cable route system integrated Cubis' MULTIduct™ cable protection system and STAKKAbox™ ULTIMA network access pit and access covers. Cubis' buried cable route system is quickly installed due to its light weight properties (all parts below 25kg), lack of specialist equipment and reduced excavation. Installed on track upgrades can average 1km in a 20 hour possession.

Cable Troughing:

Cubis offers a number of cable trough solutions that offer an innovative, lightweight, secure troughing system that has been used worldwide in different extremes of temperatures. Cable trough comprises of 1 metre long units that connect together allowing for rotation in the unit to follow gentle curves in the track. Lightweight cable trough offers significant health and safety advantages over traditional concrete troughing systems.

STAKKAbox™ ULTIMA Access Pit System:

STAKKAbox™ access pits are adaptable to the unique requirements of each site. This means ordinary site tools can be used to retrofit around existing networks by drilling duct entries or cutting the pit sections horizontally. The seamless integration across the Cubis product range enables the construction of bespoke systems with access cover options including concrete infill, composite, recessed and steel fabricated. Cubis' pit options & accessories range allows installers the ability to simply place, connect ducts, backfill and walk away.

Testing:

Cubis' MULTIduct™ products have undertaken testing by accredited testing facilities. Crushing load universally distributed load, point load, cable pulling, tension load, lateral bending load between 2 MULTIduct™ units, bend adaptor, MULTIduct™ grout pressure, shear load and torque tests. Testing data is available upon request.



Cable Troughing



Buried Cable Routes



STAKKAbox™ ULTIMA Access Pit System

Contact us:

Head Office:
4 Silverwood Industrial Estate,
Lurgan, Co. Armagh,
BT66 6LN,
Northern Ireland

Telephone: +44 (0)28 38 313 100
Email: info@cubis-systems.com

www.cubis-systems.com



Driven by Innovation

Cubis is Europe's leading manufacturer of network access pit and ducting systems, used in the construction of infrastructure networks for rail, telecoms, water, construction and power markets.

Cubis has developed an innovative approach in an old-fashioned industry. This has been achieved by developing quality products which replace traditional construction materials, like bricks and concrete, with lightweight plastics incorporating intelligent design features. These can then be installed faster and ultimately save our customers both time and money.

Cubis manufactures preformed network access pit systems STAKKAbox™, AX-S™ access covers, MULTIduct™ multiple duct system and RAILduct™ cable trough at its manufacturing sites throughout the UK and Ireland these products are exported to more than 25 countries throughout the World.

At Cubis we pride ourselves on delivering technical customer support, new innovation, product quality and the highest levels of customer satisfaction.